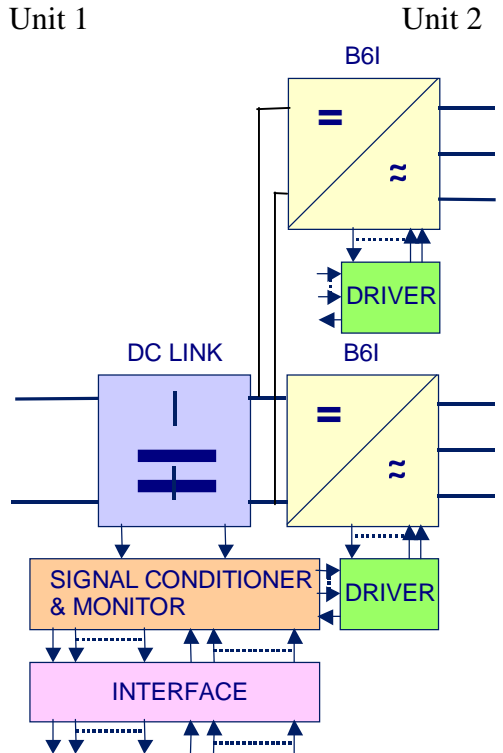

Key Data

2 x 3 x 330A AC at 500V AC

General Information

Stack with IGBT, heatsinks, capacitors, drivers and sensors for several inverter applications. These are only technical data! Please read heedful the complete documentation and attend the adopted design environment! Especially the EMC environment and the controller functionality.

Topology	DC Link + 2B6I		
Load Type	Resistive, inductive load		
Cooling	Forced air, Fan excluded		
Targed Application	Solar		
Extra	Available in Master [M] or Slave [S] Configuration		
Drivercore	Scale Driver		
Monitors	Current-, Voltage-, Temperature-Monitoring		
Module (Unit1)		n.a.	
Module (Unit2)	IGBT	6x FF600R12KL4C	
Interface	Electrical, opt. optical		
Standards	EN50178, UL94, prepared for UL508C		
Product ID (eupec)	Master 24965 Slave 24966		
Drawing No.	38000021_S5_MB		
Circuit Diagram No.	57000002		

Electrical Data

	Parameter		Min	Typ	Max	
Assumed Linevoltage	For Isolation-Management	VLine		500		VRMS
DC Link Voltage		VDC	275	675	900	Vav
DC Link Overvoltage Shutdown	Within 100µs			VDCmax		V
DC Link Current	At IUnit2, VUnit2, cos_φUnit2	IDCLink Input	660	735		Aav
Voltage Unit1		VUnit1		-		VRMS
Continius Current Unit1	ϑ=ϑair_inlet	IUnit1			-	ARMS
Shorttime Current Unit1	10s, every 180s, initial load = IUnit1	IUnit1_10			-	ARMS
Pulse Current Unit1	Sinehalfwave 20ms				-	Apeak

DC Current at Unit1	No rotating field, $\vartheta = \vartheta_{air_inlet}$,	IUnit1_DC			-	Aav
Overcurrent Shutdown Unit1	Percentage of IUnit1. Within 15 μ s				-	%
Switching Freq. Unit1		fsw1			-	Hz
Power Losses Unit1	$V = V_{unit1_min}$, $I = I_{Unit1}$, $fsw = fsw1$	Ploss1			-	W
Voltage Unit2	Depending on Controller	VUnit2		500	550	VRMS
Displacement factor		cos_φUnit2	-0,9		+0,9	
Continious Current Unit2	$\vartheta = \vartheta_{air_inlet}$, $\vartheta_{chip} \leq 125^{\circ}C$ $f_{Unit2} > 5Hz$ Both B6I connected in parallel (1U1 ->2U1..)	IUnit2			660	ARMS
Shorttime Current Unit2	$\vartheta_{water_inlet} \leq 40^{\circ}C$, 10s, every 180s, initial load = IUnit2	IUnit2_10			792	ARMS
Pulse Current Unit2	Sinehalfwave 20ms, starting from IUnit2.	IUnit2peak			-	Apeak
DC Current at Unit2	No rotating field, $\vartheta = \vartheta_{air_inlet}$,	IUnit2_DC			0,4* IUnit2	ADC
Overcurrent Shutdown Unit2	Percentage of IUnit2. Within 15 μ s			125		%
Switching Freq. Unit2		fsw2			3000	Hz
Power Losses Unit2	$I = I_{Unit2}$, $fsw = fsw2$	Ploss2		5380		W
Power Losses (PCB and Capacitor)		Ploss_aux			350	W
Filterresistors at Output Unit2	Applicable for Sinewavefilters (damping, optionally)	RFilter		-		Ohm
		PRFilter		-		Watt
Auxiliary Voltage		Vaux	18	24	30	Vav
Auxiliary Power Demand	$V_{aux} = 24 V_{av}$, to feed with B6U	Paux	80			W
EMC Test	According EN61800-3 at named interfaces	Power	VBurst	2		kV
		Control	VBurst	1		
		Aux (24V)	VSurge	1		kV
Insulation Test Voltage	According EN50178 $f = 50Hz$, $t = 1min$	Visol		1,8		kVRMS

Important Component Data

DC Link Capacitor		CDC		18,8		mF
DC Link Capacitor		Type	Elcap			
Capacitor Design Lifetime	Loadcycle for: Wind	LTD		-		Year
	Loadcycle for: Solar	LTD		20		Year

(eupec approximation)	Loadcycle for: Industrial Drive ($\vartheta_{air}=35^{\circ}\text{C}$, $I=0,8$, Duration=24h/Day)	LTD		-		Year
-----------------------	---	-----	--	---	--	------

Requirements to the Powersource

Assumed Inductance Of Feeding Powersource	(Necessary inductance not included, feeded by B6U)	LFeed		95		μH
---	--	-------	--	----	--	---------------

Fan Data (assumed when excluded)

Fan Type	Assumed		2Stck. Ziehl-Abegg RF22P-2DK.3F.1R			
Fan Voltage		V_{Fan}		400		V_{RMS}
Fan Frequency		f_{Fan}		50		Hz
Fan Current		I_{Fan}		1,95		ARMS
Fan Air Pressure	Assumed	Δp_{AirFan}		700		Pa

Controller Interface Data

Driver	See Datasheets	PCB	TR10x			
Paralleling Interface	Master (only first B6I)	PCB	SAD101			
	Slave		-			
	See Datasheet					
Optical Interface	Master (only first B6I) (optionally)	PCB	OEA101			
	Slave		-			
	See Datasheet					
Digital Input Level	Resistor to Gnd (1,8k) High = on min 15mA	V_{in}	0		15	V
Digital Output Level	Open collector Low = ok max 15mA	V_{out}	0		15	V
Analog Current Outputs Unit1	Load max 1mA at I_{Unit1}			-		V
Analog Current Outputs Unit2	Load max 1mA at I_{Unit2}			4		V
Analog DC Link Voltage Output	Load max 1 mA At V_{DCmax}	V_{DCout}		9		V
Analog Temperature Out	Load max 1mA At $\vartheta_j=125^{\circ}\text{C}$	$V_{\vartheta out}$		9		V
Optical Input Level	optionally		12			μW
Optical Output Level	optionally				60	μW

Requirements to the Controller

EMC Protection	According EN61800-3 at auxiliary power and controlinterface		1			kV
----------------	---	--	---	--	--	----

EMC Environment			Shieldconcept with TE (True Earth) separated from PE, HF conform installation			
Drive Pulse Time		ton_min	10			μs
Blockout Time		tpause	10			μs
Overvoltage Shut Down Reaction Time	After overvoltage message by PowerSTACK Interface				50	μs
Overcurrent Shut Down Reaction Time	After overcurrent message by PowerSTACK Interface				10	μs

Mechanical Data

Airvelocity	ϑAir=20°C Pair=1013 hPa Dry- and dustfree, measured outside of heatsink. According DIN 41882	vAir		12		m/s
Airflow heatsink		dV/dtAir	-	2200		m³/h
Air Pressure Drop heatsink		ΔpAir		700		Pa
Waterflow heatsink	According Coolingwater Specification from eupec for copper tubes	dV/dt Water	-			l/min
Water Pressure Drop heatsink		ΔpWater		-		Pa
Water connection						
Dimensions	Width x Depth x Hight		1090	600	305	mm
Mass	Approximation			101		kg
Storage Temperature Range		ϑstor	-40		+65	°C
Operating Temperature range (PCB and Capacitor)	Minimal 0 °C for optional optical interface	ϑop	-25 (0)		+55	°C
Cooling Air Inlet Temperature (Heatsink)	Heatsink temperature > -25°C	ϑair_inlet	-25		+40	°C
			-40			
Cooling Water Inlet Temperature (Heatsink)		ϑwater_inlet	-		-	°C
Cooling Airvelocity (PCB and Capacitor)		vAir_PCB	2			m/s
Air Pressure	Standard atmosphere	pAir	900		1100	hPa
Humidity	No Condensation	Rel. F	0		95	%
Installation Height			0		1000	m
Vibration	EN60068-2-6, Fc 10..59Hz 0,075mm				10	m/s²
Permanence Vibration	EN60068-2-6, Fc 10-150Hz, 20 Cycles				20	m/s²

ModSTACK



Datasheet: 2B6I 500/800-330G M, S

Preliminary Data

Shock	EN60068-2-27, Ea Halfsine 11ms, 3 pulses				100	m/s ²
Protection Degree				IP00		
Pollution Degree				2		
Overvoltage Category				III		

Derating Curves (IGBT Part)

Current derating at low rotating field frequency (f_0). **Maximal 100% current is allowed.**

$\cos(\phi) = 0.64$, (motor)
 $\Theta_{air} = 40^\circ\text{C}$

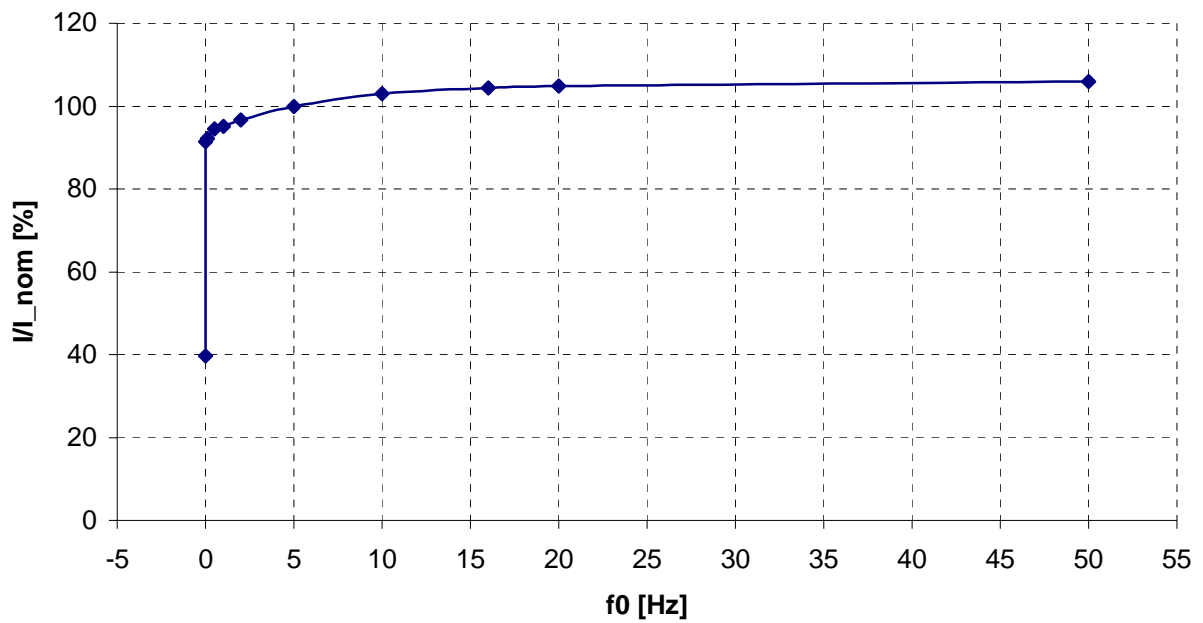

cos(phi) = -0.64, (generator)
Theta_air = 40°C

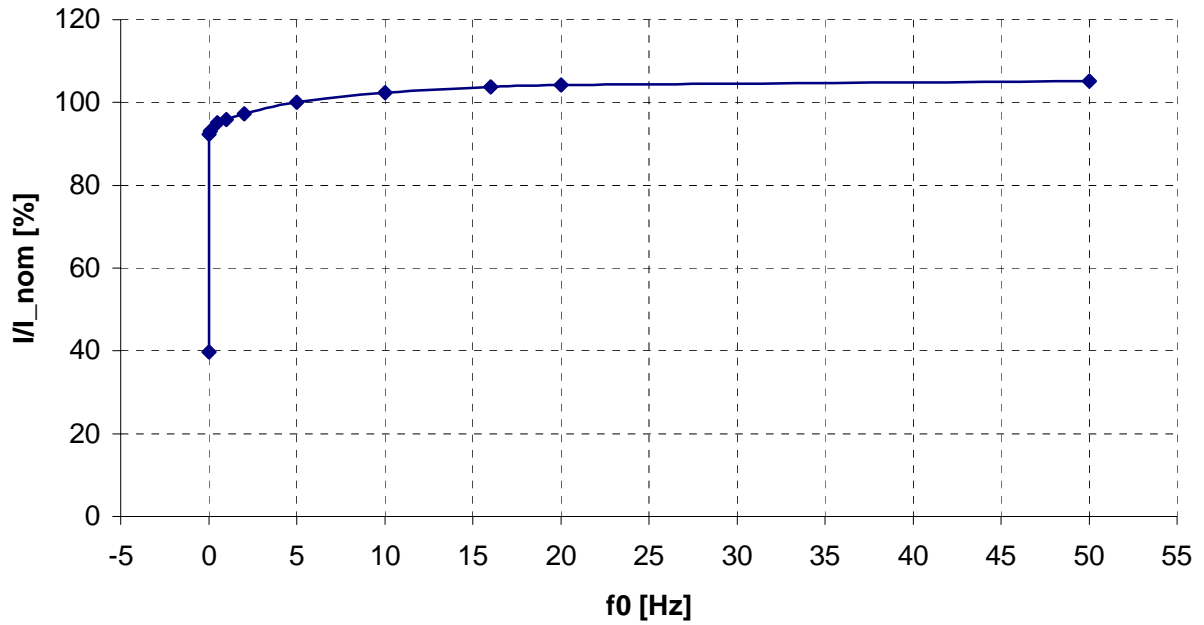

Current derating at different switching frequencies. See datatable for nominal switching frequency. In this drawing 2500Hz ist assumed. **Maximal 100% current is allowed.**

**IGBT, $\cos(\phi) = 0.64$
Theta_{air} = 40°C**

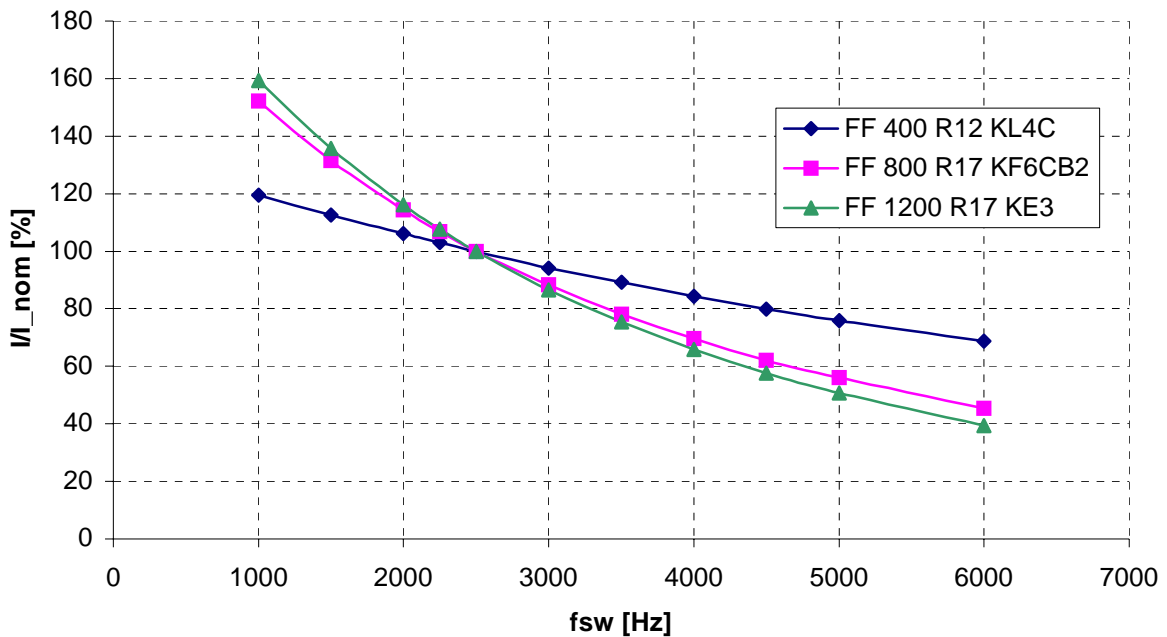

**Diode, $\cos(\phi) = 0.64$
Theta_{air} = 40°C**

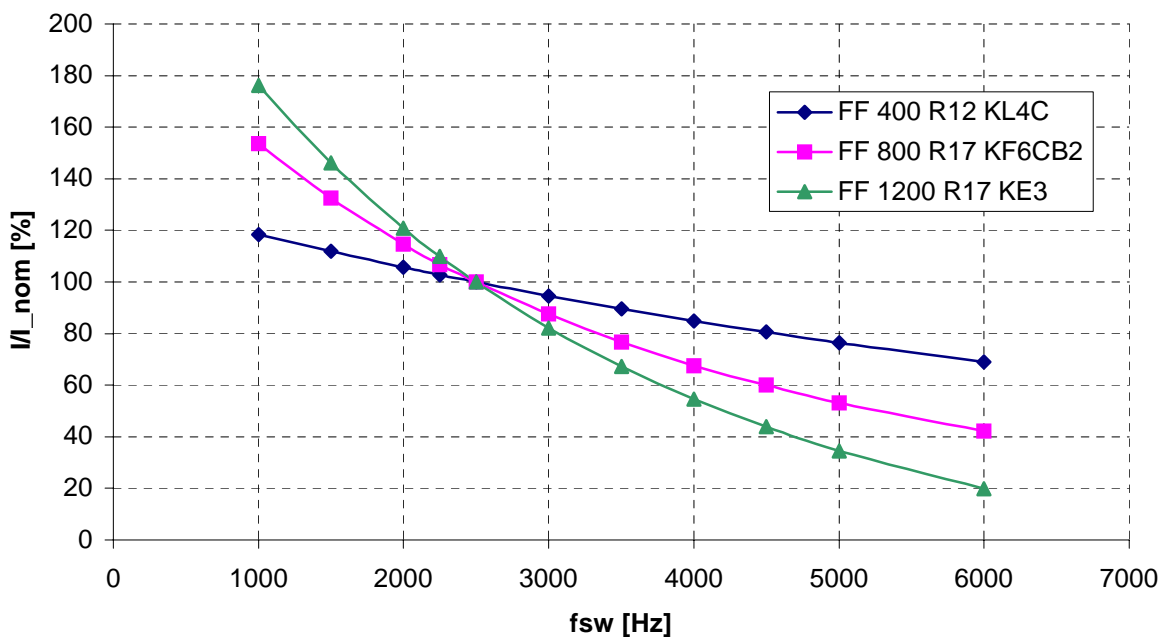

IGBT, $\cos(\phi) = -0.64$
 $\Theta_{air} = 40^{\circ}\text{C}$

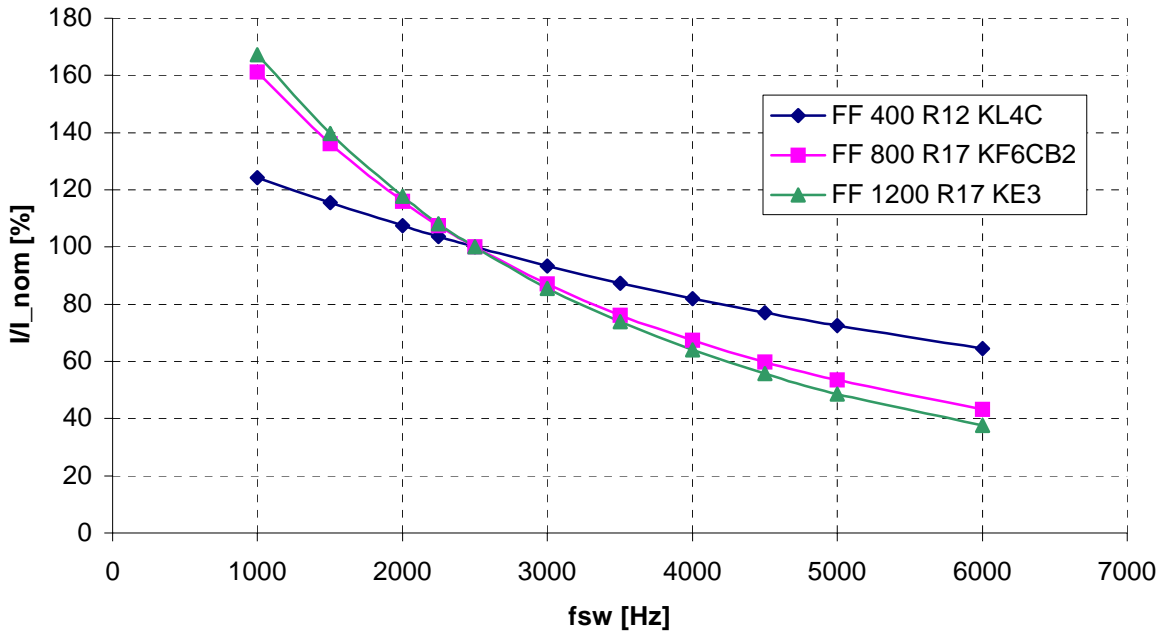

Diode, $\cos(\phi) = -0.64$
 $\Theta_{air} = 40^{\circ}\text{C}$

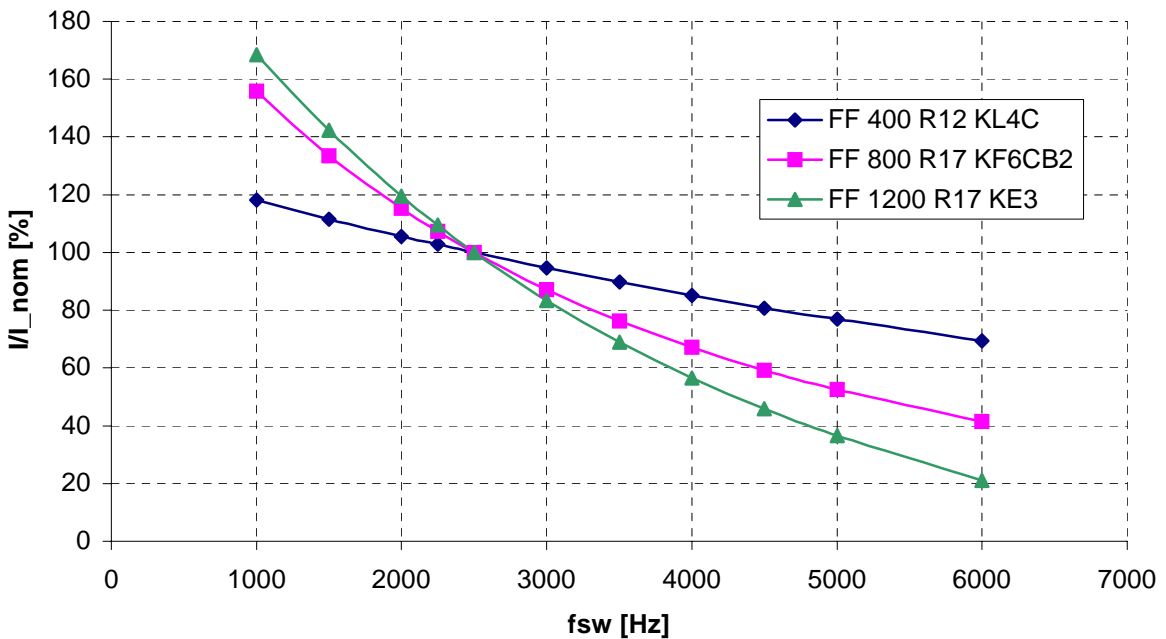

Miscellaneous

This technical information specifies semiconductor stacks but promises no characteristics. It is valid in combination with the belonging technical notes.

This document may be changed without prior notice.

Warning!

Prior to installation and commissioning all safety notices and warnings and all warning signs attached to the equipment have to be carefully read. Make sure that all warning signs remain in a legible condition and missing or damaged signs are replaced.

The safety instructions have to be strictly adhered to.

The manual contains detailed information on all technical topics with regard to the eupec ModSTACK. For further details regarding publications of the eupec ModSTACK and information on other publications in the area of ModSTACKs please contact your nearest eupec branch or visit our website: <http://www.eupec.com>.

©eupec GmbH 2003. All rights reserved

Prepared by	J.Schiele	2003-04-04	Date of publication	
Approved by	H.Nübel	2005-11-28	Revision	3, 28.11.2005

2B6I / / - -F/G/W
 ModSTACK Size 3
 38000032 MB

